

START 1 Resistor - Weerstand - Résistance - Widerstand - Resistencia - Motstand - Vastus - Resistenze

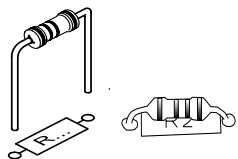

◇ R2 : 1M

(Brown, Black, Green) - (Bruin, Zwart, Groen) - (Brun, Noir, Vert) - (Braun, Schwarz, Grün.) - (Brun, Svart, Grön) - (Ruskea, Musta, Vihreä) - (Marrón, Negro, Verde) - (Castanho, Preto, Verde) - (Marrone, Nero, Verde)

2 Diodes

Watch the polarity!
Attention à la polarité!

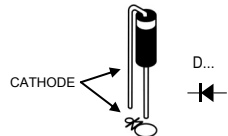

◇ D1 ... D4 : 1N4007

3 Resistor - Weerstand - Résistance - Widerstand - Resistencia - Motstand - Vastus - Resistenze

◇ R1 : 470

(Yellow, Purple, Brown) - (Geel, Paars, Bruin) - (Jaune, Violet, Brun) - (Gelb, Violet, Braun) - (Gul, Lila, Brun) - (Keltainen, Purppura, Ruskea) - (Amarillo, Morado, Marrón) - (Amarelo, Violeta, Castanho) - (Giallo, Viola, Marrone) - (Gul, Violet, Brun)

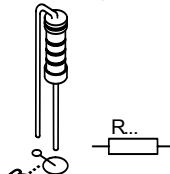

4 LED

Watch the polarity!
Attention à la polarité!

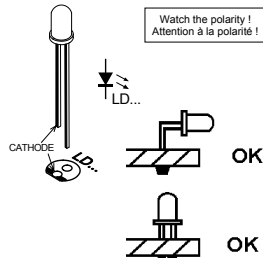

◇ LD1 : 3mm (blue)

5 Terminal block

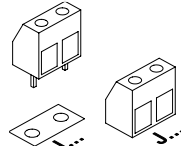

◇ 2p

6 Capacitor

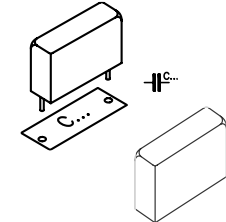

◇ C1 : 0,1µF / 250 - 275VAC



7 Connection

100 ... 240VAC
50 - 60Hz

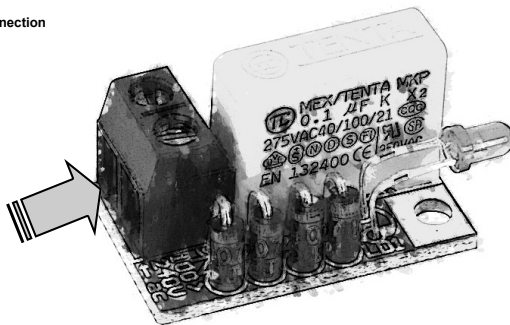

8 Diagram

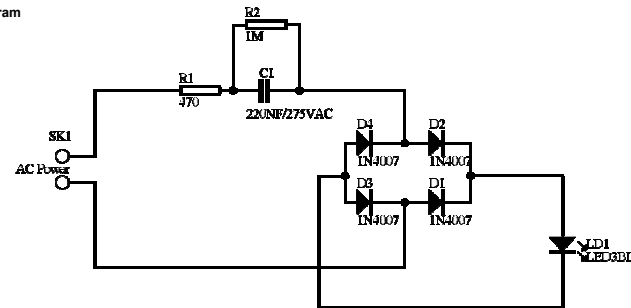

SAFETY AND HAZARD WARNINGS

This kit operates on lethal AC power voltage - Mount the kit in a protective cabinet prior to applying AC power - Do not modify the circuit - Wait 10 minutes before touching the kit after disconnecting the AC power - This kit is NOT intended for children.



WAARSCHUWINGEN OMTRENT VEILIGHEID EN GEVAREN

Deze kit wordt gevoed door een gevaarlijke wisselspanning - Monteer deze kit in een beschermende behuizing alvorens deze onder spanning te brengen - Het circuit mag niet gewijzigd worden - Wacht 10 minuten na het uitschakelen van de spanning alvorens de kit aan te raken - Deze kit is NIET geschikt voor kinderen.



AVERTISSEMENT SUR LA SÉCURITÉ ET LES DANGERS

Ce kit est alimenté par une tension CA dangereuse - Monter le kit dans un boîtier protectif fermé avant sa mise sous tension - Ne pas modifier le circuit - Patienter 10 minutes après la déconnexion de la tension CA avant de manipuler le kit - Ce kit ne convient PAS aux enfants.



ADVERTENCIAS EN RELACIÓN CON LA SEGURIDAD Y LOS RIESGOS

Este kit está alimentado por una corriente alterna muy peligrosa - Monte el kit en una caja protectora cerrada antes de conectarlo a la red eléctrica - No modifique el circuito - Espere 10 minutos después de la desconexión de la tensión CA antes de manipular el kit - Este kit NO es apto para los niños.



WARNUNGEN IN BEZIEHUNG AUF DIE SICHERHEIT UND DIE GEFAHREN

Dieser Bausatz wird mit einem gefährlichen Wechselstrom versorgt - Montieren Sie diesen Bausatz in einem Schutzgehäuse, ehe Sie ihn mit dem Netz verbinden - Ändern Sie den Kreis nicht - Warten Sie 10 Minuten nach der Trennung vom Netz, ehe Sie den Bausatz berühren - Dieser Bausatz eignet sich NICHT für Kinder.